

C34-10 Direct Vent Gas Stove

Model	C34-NG10	C34-LP10
Fuel Type	Natural Gas	Propane
Minimum Supply Pressure	5.0" W.C. (1.25 kPa)	12.0" W.C. (3.00 kPa)
Manifold Pressure - High	3.8" W.C. (0.95 kPa)	11" W.C. (2.74 kPa)
Manifold Pressure - Low	1.1" W.C. (0.27 kPa)	2.9" W.C. (0.72 kPa)
Orifice Size	#36	#52
Minimum Input	16,000 BTU/h	16,000 BTU/h
Maximum Input	32,000 BTU/h	32,000 BTU/h
Vent Sizing	4" Inner / 6-5/8" Outer	4" Inner / 6-5/8" Outer

Approved Venting Systems	
Flex Vent Systems:	FPI AstroCap™ Flex Vent
Rigid Pipe Vent Systems:	Simpson Direct Vent Pro® American Metal Products® Amerivent Direct Security Secure Vent® Selkirk Direct-Temp™ Metal-Fab® Sure Seal

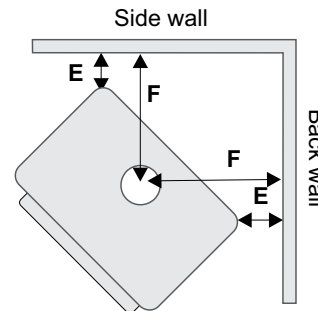
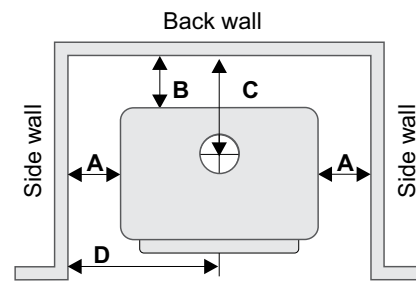
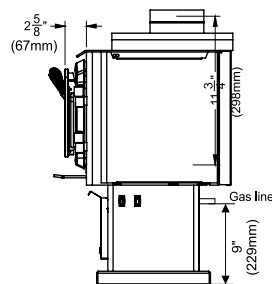
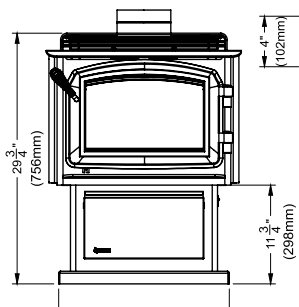
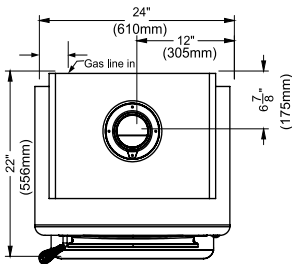

Dimension	Description	C34
A	Unit Width	24" (610mm)
B	Unit Height	29-11/16" (737mm)
C	Unit Depth	21-5/8" (549mm)
D	Pedestal Height	11-3/4" (298mm)
E	Cast Leg Height (including Bottom shield)	11-3/4" (298mm)
F	Bottom shield Height	4" (102mm)
G	Vent centerline to Side	12" (305mm)
H	Vent centerline to Back	7" (178mm)
I	Gas Line Height (from base)	9" (229mm)
J	Side to Gas Line	4-1/2" (114mm)

C34 Clearances to Combustibles		
Dimension	Description	C34
A	Side Wall to Unit	10" (250mm)
B	Back Wall to Unit	6" (150mm)
C	Back wall to Vent Center line	13" (559mm)
D	Side wall to Vent Center line	22" (330mm)

Corner Clearances		
Dimension	Description	C34
E	Side wall to unit	1.5" (38mm)
F	Side wall to Vent Center line	14" (356mm)

Minimum ceiling height is 36" (914mm) from top of unit.
Minimum clearance to vent is 1-1/4" (32mm).

The above listed clearances are minimum distances to combustible materials. When installing on carpet or vinyl flooring the bottom pedestal cover plate must be installed.

Regency Direct Vent System Horizontal Terminations Only

These venting systems, in combination with the **C34** Direct Vent Gas Fireplace, have been tested and listed as a direct vent heater system by Warnock Hersey. The location of the termination cap must conform to the requirements in the Vent Terminal Locations diagram.

FPI Direct Vent (Flex) System Termination Kits include all the parts needed to install the C34 using a flexible vent.

FPI Kit #	Length	Contains:
#946-116	2 Feet	<ol style="list-style-type: none"> 6-5/8" Rigid Pipe Section (Kit length) 4" flexible liner (Kit length) spring spacers (4) 90° Elbow Adjustable pipe section 13-1/2" to 24" thimble cover (1) thimble (1) adapter AstroCap termination cap (1)
#946-216	4 Feet	<ol style="list-style-type: none"> trim collar (2) tube of Mill Pac (1) S.S. screws #8 x 1-1/2", self-tap, (12) Blk. screws #8 x 1-1/2", self-tap, (14) Blk. screws #8 x 1-1/2" drill point, (4) S.S. screws #8 x 1-1/2" drill point, (4) Wood screws #8 x 1" (8) vinyl siding standoff (optional #946-206)

Notes:

- Liner sections should be continuous without any joints or seams.
- Only Flex pipe purchased from Regency may be used for Flex installations.
- Horizontal sections must be supported every 3 feet.

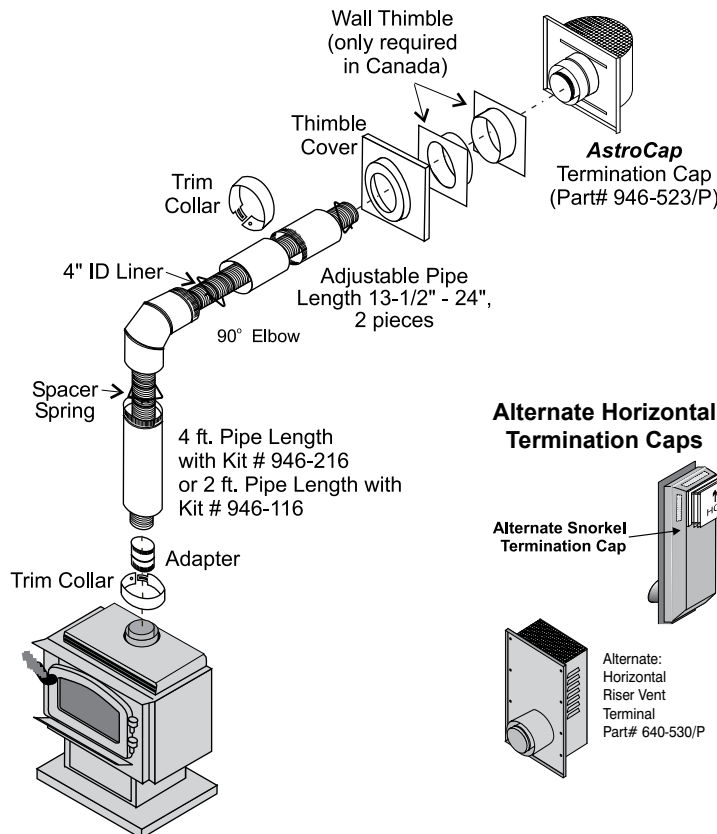

Alternate Horizontal Termination Caps

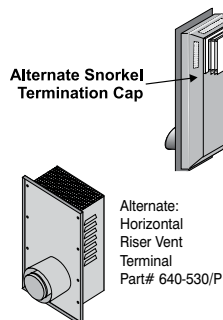

Snorkel Terminations

Snorkel Terminations:

For installations requiring a vertical rise on the exterior of the building, 14-inch and 36-inch tall Snorkel Terminations and the Riser Vent are available. Follow the same installation procedures as used for standard Horizontal Termination. NEVER install the snorkel upside down.

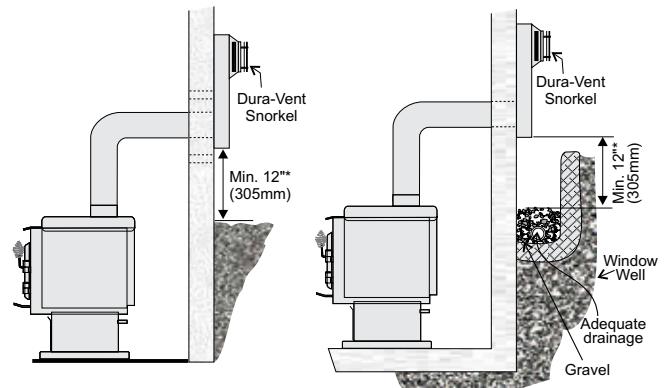

Below Grade Snorkel Installation

If the Snorkel Termination must be installed below grade, i.e. basement application, proper drainage must be provided to prevent water from entering the Snorkel Termination. Refer to Rigid Pipe Installation instructions for details. Do not attempt to enclose the Snorkel within the wall, or any other type of enclosure.

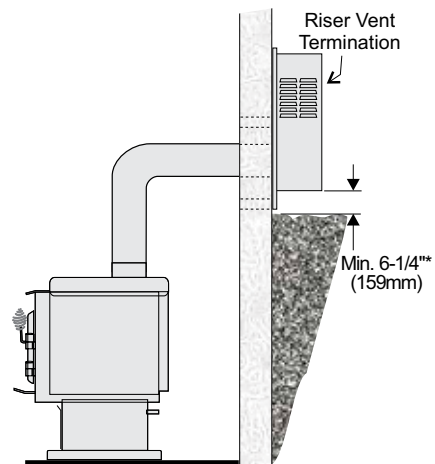

C34 Gas Stove

Vent Restrictor Position

Vent restriction is required for certain venting installations, see the diagrams in "Venting Arrangement" section to determine if they are required for your installation.

The vent restrictor has three settings: "C" Center (factory setting), "L" Left, and "R" Right. Simply loosen the screws and push the vent restrictor plate to the correct position. Tighten the screws.

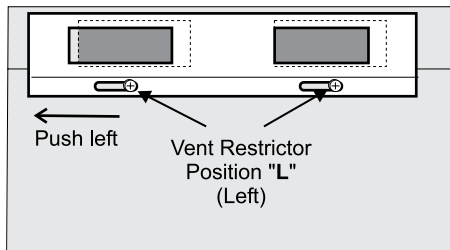
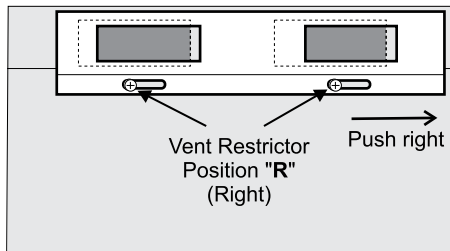
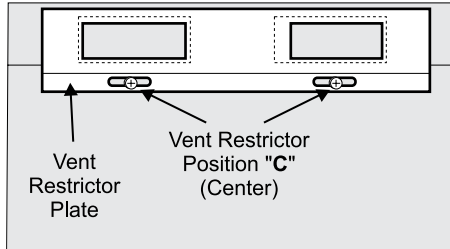

Rigid Pipe Venting Systems

Horizontal or Vertical Terminations

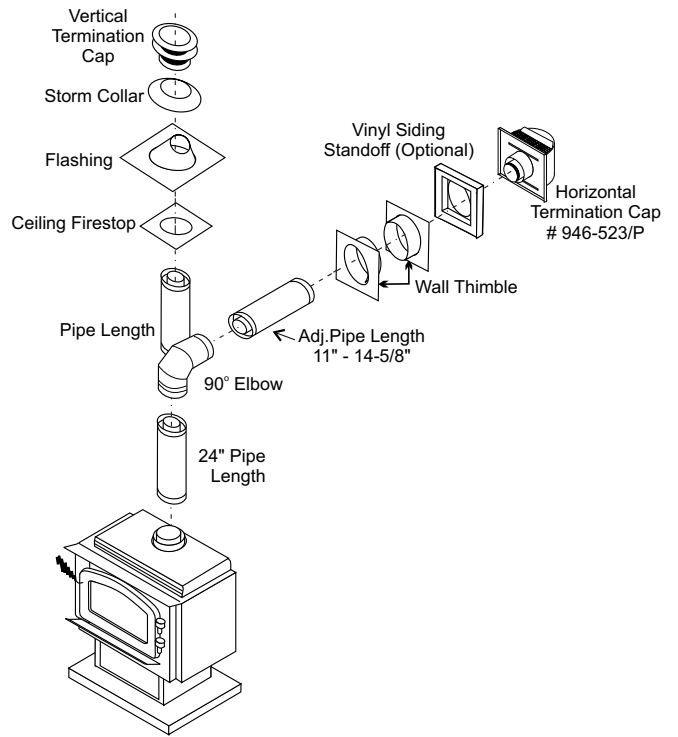

Venting Arrangements - Vertical Terminations

Rigid Pipe System

(Propane & Natural Gas)

The C34 is approved for a maximum 30 ft. straight vertical, with **Rigid Pipe** vent systems for Propane and Natural Gas.

The shaded area in the diagram (right) shows allowable venting configurations with a maximum of two 45° elbows allowed. Terminations falling in the shaded area must have the Vent Restrictor Position set to "R" Right.

- Vent must be supported at offsets.
- Horizontal sections must be supported every 3 feet
- Firestops are required at each floor level and whenever passing through a wall.
- Maintain clearances to combustible materials.
- Minimum of 1' pipe section between elbows.

Vertical Venting with Two (2. 90° Elbows)

Two 45° elbows = One 90° elbow

Option	V	H	V+ V1	Maximum total pipe length, of all sections, must not exceed 30 feet.
A)	1' Min.	4' Max.	2' Min.	Total horizontal sections must not exceed 8 feet. Minimum of 1 foot between 90° elbows is required.
B)	2' Min.	5' Max.	3' Min.	
C)	3' Min.	6' Max.	4' Min.	
D)	4' Min.	7' Max.	5' Min.	
E)	5' Min.	8' Max.	6' Min.	

Vent Restrictor in position "C" (Center),

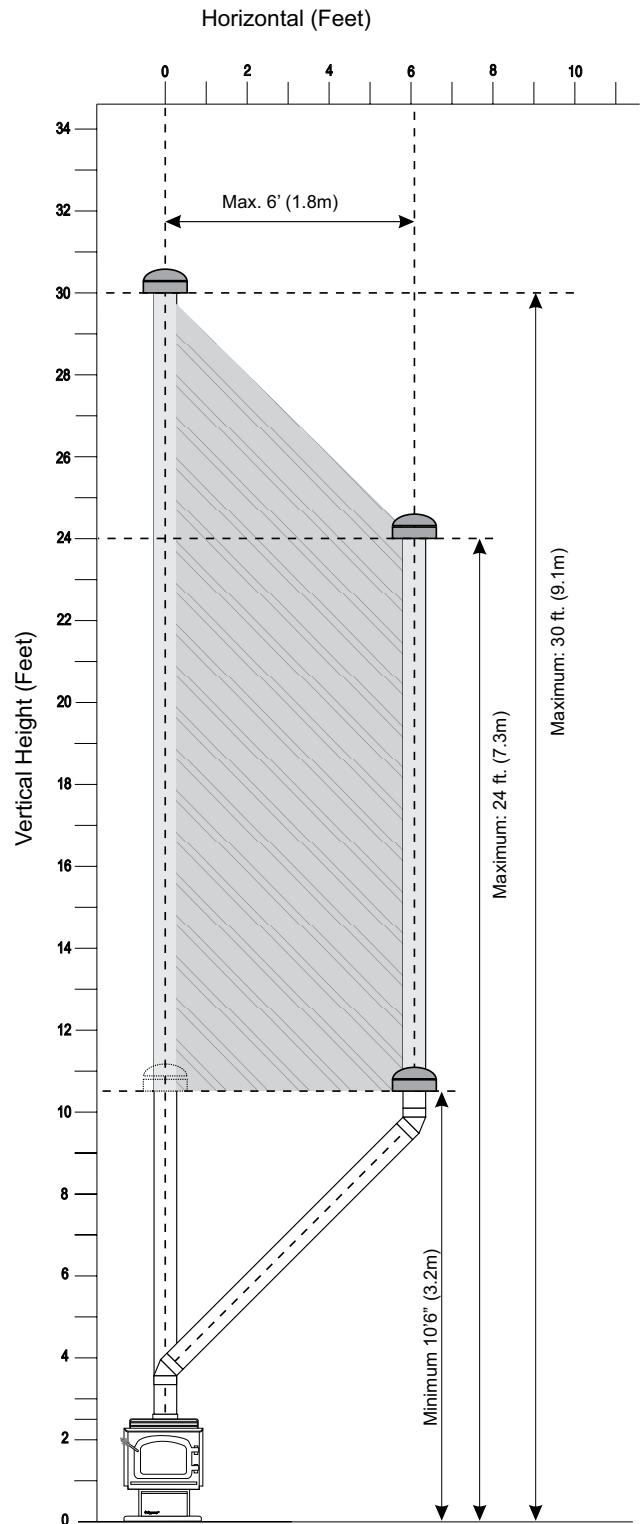
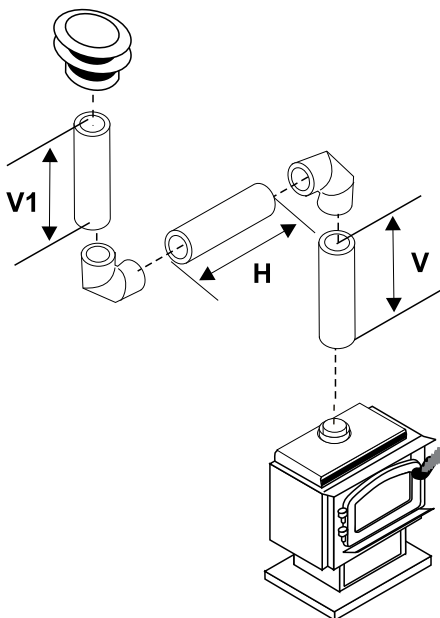

C34 Gas Stove

Venting Arrangements - Horizontal Terminations

This diagram shows all allowable combinations of vertical runs with horizontal terminations, **using one 90° elbow** (two 45° elbows equal one 90° elbow).

The lightly shaded area, , in the diagram shows allowable combinations with Vent Restrictor in position "C" (Center), refer to page 113.

The darker shaded area, , in the diagram shows allowable combinations with Vent Restrictor in position "L" (Left).

- **Maintain clearances to combustibles.**
- **Horizontal vent must be supported every 3 feet.**
- **Firestops are required at each floor level and whenever passing through a wall.**

A vent guard may be required as per local codes, refer to "Exterior Vent Termination Locations".

Note: FPI Direct Vent System (Flex) is only approved for horizontal terminations.

Horizontal Venting with Two (2) 90° Elbows

Two 45° elbows = One 90° elbow

Option	V	H + H1	Maximum total pipe length, of all sections, must not exceed 30 feet. Total horizontal sections must not exceed 8 feet. Minimum of 1 foot between 90° elbows is required.
A)	4' Min.	6' Max.	
B)	5' Min.	7' Max.	
C)	6' Min.	8' Max.	

Vent Restrictor in position "C" (Center).

